

Pressure Switch

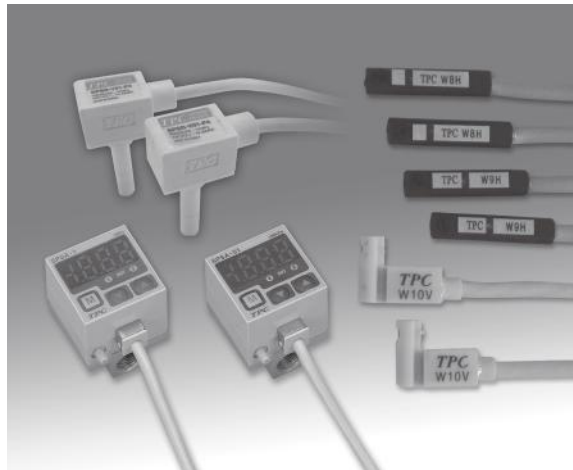

- Digital Pressure Sensor
 - Series SPSA 983
- Micro Vacuum Sensor
 - Series SPSB 992
- Auto Switch 994
- Compatible Pressure Switch
 - Series SPS 1002

※ Specifications in this catalogue may be changed for product performance upgrade without notice.
 Inquiries can be made to the manufacturer when purchasing the product.

Digital Pressure Switch Series SPSA

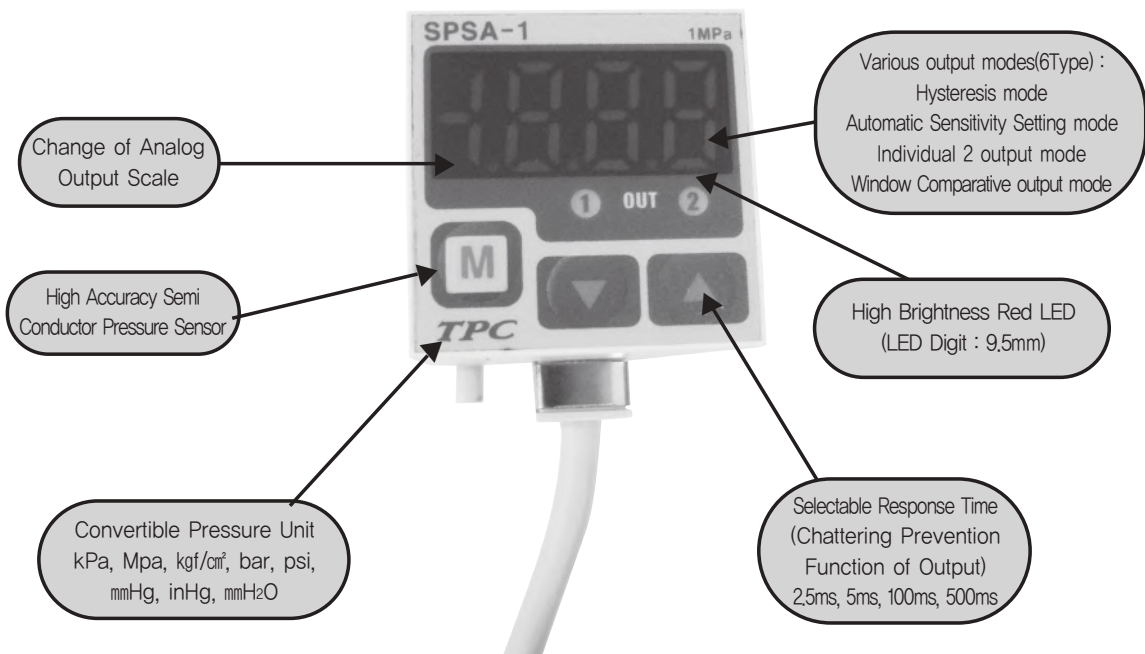

Precision measurement of Pneumatic Pressure in Piping and Pneumatic products is necessary and in being used in Industrial Progress, Inspection Progress, Control & Analysis Equipments.

Digital Sensors of TPC can effectively protect equipments by extraordinary pressure control from various unstable factors such as supply pressure, flow, ambient temperature change etc.

Digital Sensors of TPC furnish the most stable conditions with high accuracy and precision control.

Series SPSA

Digital Pressure Sensor

SPSA

SPSB

Auto Switch

SPS



- HIGH ACCURACY SEMI CONDUCTOR PRESSURE SENSOR
- HIGH BRIGHTNESS RED LED.(DIGIT:9.5MM)
- CONVERTIBLE PRESSURE UNIT
- VARIOUS OUTPUT MODES
- CHATTERING PREVENTION FUNCTION OF OUTPUT
- ANALOG OUTPUT(1-5VDC)
- CURRENT PROTECTION CIRCUIT, REVERSE POWER POLARITY PROTECTING CIRCUIT

How to order

SPS A - V 01 P □ □

1 2 3 4 5 6

1 Model

SPS : Pressure Sensor

2 Body Type

A : Square(30mm×30mm)

3 Pressure

Type	Range of Rating Pressure
01	0~100kPa(14.5psi)
1	0~1000kPa(145psi)
V01	-101.3~0kPa(-14.7~0psi)
C01	-100.0~100kPa(-14.5~14.5psi)

※ Blank : Standard pressure
V : Negative pressure(Vacuum)
C : Vacuum, Low pressure

4 Output

Blank : NPN Open Collector Output
P : PNP Open Collector Output

5 Port Size

Blank : Rc(PT)1/8
U : NPT1/8

6 Option

Blank : With Bracket(Bracket A, B)
C : Panel Mounting Bracket(PSO-01)
D : Panel Mounting Bracket
+Front Protection Cover(PSO-01 + PSO-02)

Pressure and Max. pressure display range

Pressure type	kPa	kgf/Cm ²	bar	psi	mmHg	inHg	mmH ₂ O
Negative pressure	0~101.3 (5.0~101.3)	0~1.034 (0.051~1.034)	0~1.034 (0.05~1.034)	0~14.70 (0.72~14.70)	0~760 (38~760)	0~29.9 (1.5~29.9)	0~103.4 (5.1~103.4)
Standard pressure	0~100.0 (-5.0~110.0)	0~1.020 (-0.051~1.122)	0~1.020 (-0.050~1.100)	0~14.50 (-0.72~15.90)	-	-	-
	0~1000 (-50~1013)	0~10.20 (-0.51~11.22)	0~10.20 (-0.50~11.00)	0~145.0 (-7.2~159.0)	-	-	-

※() is Max. pressure display range.

※mmH₂O Unit : Displayed pressure numberX100

Input conversion chart

from \ to	Pa	kPa	MPa	kgf/Cm ²	mmHg	mmH ₂ O	psi	bar	inHg
1kPa	1000.000	1	0.001000	0.010197	7.500616	101.9689	0.145038	0.010000	0.2953
1kgf/Cm ²	98069.10	98.06910	0.098069	1	735.5787	10000.20	14.22334	0.980691	28.95979
1mmHg	133.3220	0.133322	0.000133	0.001359	1	13.5954	0.019336	0.001333	0.039370
1mmH ₂ O	9.80665	0.00980	-	0.000099	0.0735578	1	0.00142	0.000098	0.002895
1psi	6894.939	6.89493	0.00689	0.070307	51.71630	703.07	1	0.068947	2.036074
1pa	100000.0	100.0000	0.100000	1.019689	750.062	10196.89	14.50339	1	29.52998
1inHg	3386.388	3.386388	0.003386	0.034530	25.40000	345.3240	0.491141	0.033863	1

Ex) Calculate 760mmHg as Pa unit.

: According to above chart, 1mmHg is 0.133322kPa, therefore 760mmHg will be 760x0.133322kPa=101.32472kPa.

⚠ Please read "Caution for your safety" in operation manual before using.



Series SPSA

Specifications

Pressure type		Gauge pressure			
		Negative pressure type	Standard pressure type		Vacuum, Low Pressure Type
Model	NPN	SPSA-V01	SPSA-01	SPSA-1	SPSA-C01
	PNP	SPSA-V01P	SPSA-01P	SPSA-1P	SPSA-C01P
Rated pressure range		0.0~-101.3kPa(0.0~-14.7psi)	0.0~100.0kPa(0.0~14.5psi)	0.0~1,000kPa(0.0~145psi)	-100.0~100kPa(-14.5~14.5psi)
Display pressure range		5.0~-101.3kPa (0.72~-14.7psi)	-5.0~110.0kPa (-0.72~15.9psi)	-5.0~1,100kPa (-7.25~159.5psi)	-101.3~110kPa (-14.7~15.9psi)
Max. oressyre rabge		2 times of rating pressure		1.5 times of rating pressure	2 times of rating pressure
Fluid		Air, Non-corrosive gas			
Power supply		12~24VDC±10%(Ripple P-P : Max. 10%)			
Current consumption		Max. 50mA			
Control output		· NPN open collector output ⇒Load current : Max. 100mA, Load voltage : Max. 30VDC, Residual voltage : Max. 1V · PNP open collector output ⇒Max. sink current : Max. 100mA, Residual voltage : Max. 2V			
Hysteresis		1 digit(2digit/psi) fixed		2digit/psi fixed	
Repeat error		±0.2% F · S ±1digit		±0.2% F · S ±2digit	
Response time		Selectable 2.5ms, 5ms, 100ms, 500ms			
Short circuit protection		Built-in			
Analog output		· Output voltage:1V~5VDC±2% F.S. · Zero point:Within 1VDC±2% F.S.		· Resolution:Approx. 1/200 · Linear:Within ±2% F.S. · Span:Within 4VDC ±2% F.S. · Output impedance:1kΩ	
Display method		3 1/2 digit LED 7Segment			
Min. display interval		1 digit(2digit/psi)		2digits	
Display Pressure unit		kPa, kgf/Cm ² , bar, psi mmHg, mmH ₂ O, inHg	kPa, kgf/Cm ² , bar, psi		kPa, kgf/Cm ² , bar, psi mmHg, mmH ₂ O, inHg
Characteristic of control output and displayed temp		Max. ±1% F.S.		Max. ±2% F.S.	
Analog output temper- ature characteristic		Max. ±2% F.S. (25°C(77°F) standard)			
Environment	Ambient temperature	-10°C to ±50°C(14~±122°F) (at non-dew status)			
	Storage temperature	-20°C to ±60°C(-4~±140°F) (at non-freezing status)			
	Ambient humidity	35 to 85% RH			
	Storage humidity	35 to 85% RH			
	Vibration	1.5mm amplitude at frequency of 10 to 55Hz in each of X, Y, Z directions for 2 hours			
Material		Front case : PC, Rear case : PC(Insert glas), Pressure port : die-cast(Zn)			
Protection structure		IP40(IEC standard)			
Cable		5P, Ø4, Length : 2m(0.2mm2)			
Acquirement standard		CE			
Weight		Approx. 120g(4.23ozs)			

※Weight : Without box
 ※F.S. : Full Span
 ※(*1) Output operating, hysteresis is adjustable in F-1 mode
 ※(*2) ±1% F.S. or less (25°C)

Analog output voltage-Pressure characteristic

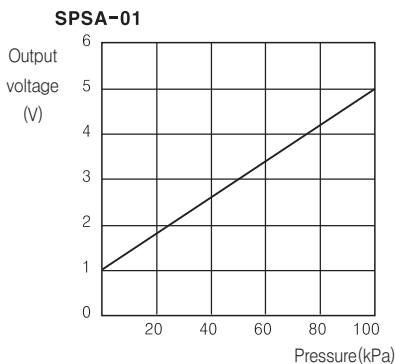

Analog output voltage linear

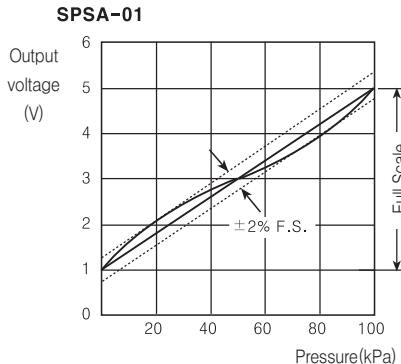

Series SPSA

Dimensions

Product

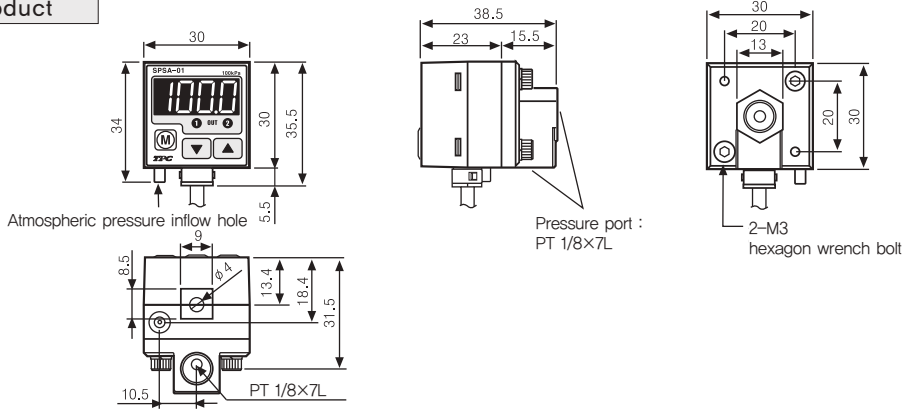

SPSA

SPSB

Auto Switch

SPS

Fixed Bracket Dimensions

●Bracket A

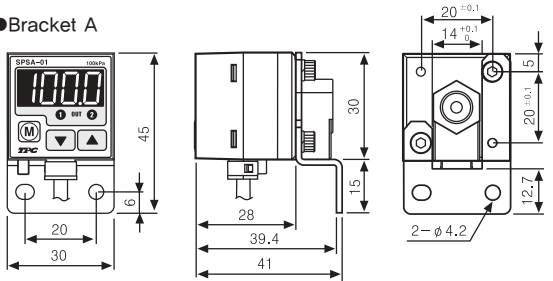

●Bracket B

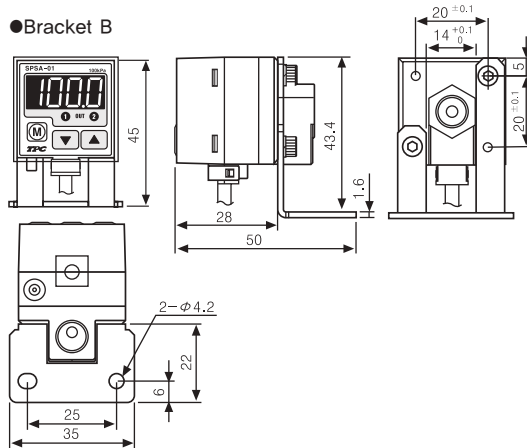

Panel Mounting Bracket Dimensions

●Accessory(OPTION)



●Accessory:front protection Cover(OPTION)

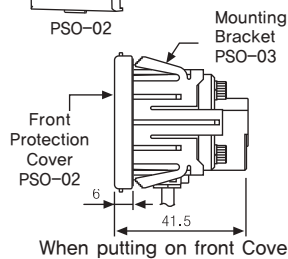
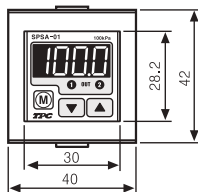

●Panel cut-out

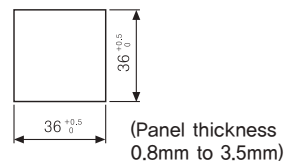

●Bracket-A

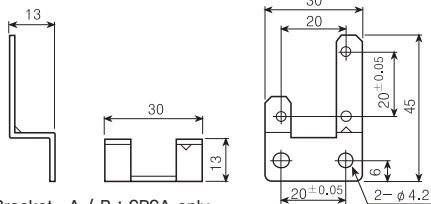

●Bracket-B

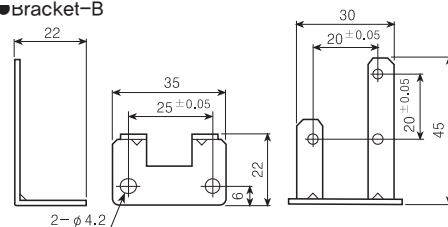

※ Bracket- A / B : SPSA only.

Series SPSA

Input/Output circuit and connection diagram

NPN open collector output type

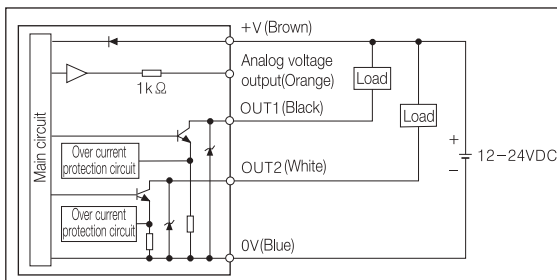

PNP open collector output type

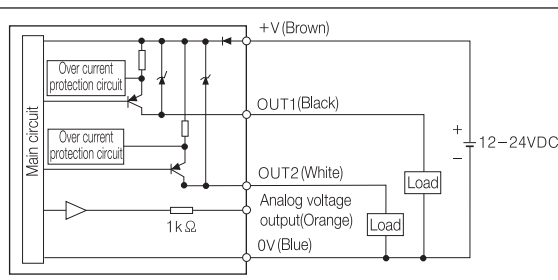

※There is no over current protection circuit in analog voltage output type. Do not connect this unit to power source or capacitive load directly.
 ※Please observe input impedance of connected equipment when using analog voltage output and be sure with voltage drop by resistance of extended wire.

Front panel identification and function

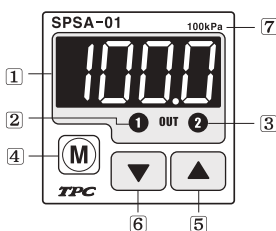

- ① 3 1/2 LED display(Red) : Display detected pressure, every setting value and display error
- ② 1 output indicator(Red) : Output 1 is ON, LED will be ON

- ③ 2 output indicator(Red) : Output 2 is ON, LED will be ON
- ④ Mode key : Parameter setting mode or preset setting mode, save setting value
- ⑤ Up key : Set the setting value to upper step in preset setting or pressure unit, output mode, response time, analog output scale, key lock, peak hold value, bottom hold value display in parameter setting.
- ⑥ Down key : Set setting value to lower step in preset setting or pressure unit, output mode, response time, analog output scale, key lock, peak hold, bottom hold display in parameter setting.
- ⑦ Range of rating pressure : It is possible to change the pressure unit in Pressure sensor. Please use different unit as labeled for your application.

Setting

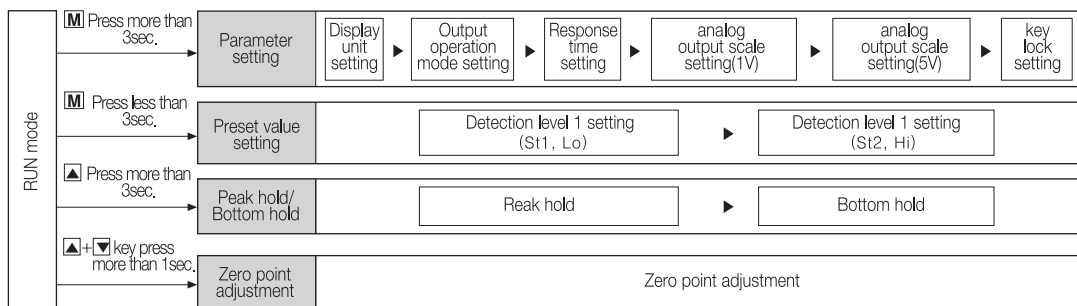

Zero point adjustment

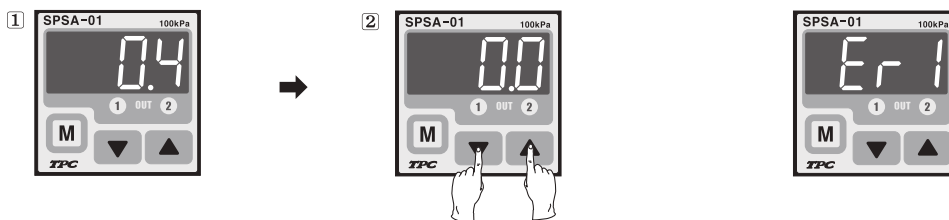

1. In state of atmospheric pressure during RUN mode, press Key and Key at the same time for over 1 sec.
2. When the zero point adjustment is completed, it will display zero(0.0, 0.00, 0.000) and return to RUN mode automatically.

If excute Zero point when external pressure has been applied, **[Er 1]** will be flashing. Please execute Zero point again in state of atmospheric pressure.
 ※Please execute Zero point adjustment regularly.

Series SPSA

Setting parameter

SPSA

SPSB

Auto Switch

SPS

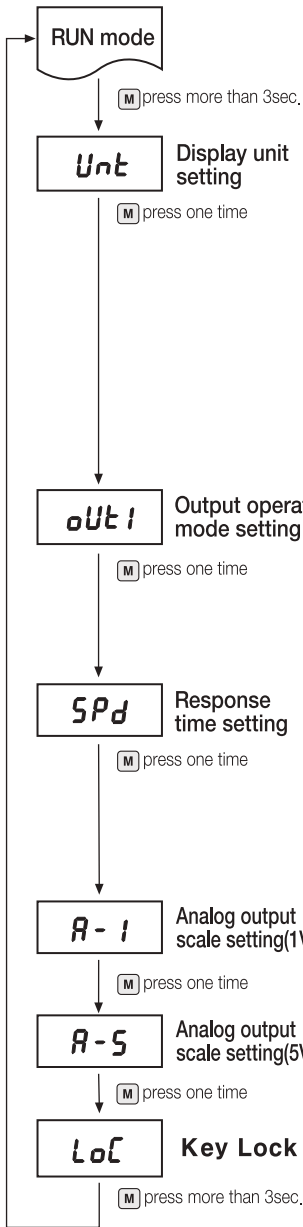

Unt and previous unit will flicker by turning on.(0.5sec.) Select the unit with **▲**, **▼** key.(Pressing **M** key momentarily, the unit will be saved, then move to the next mode)

●Negative pressure type :

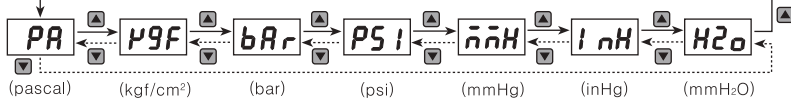

●Standard pressure type :

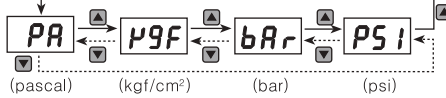

※mmH₂O unit :
displayed pressure
numberX100

out1 and previous output operation mode will flicker by turning on.(0.5sec.)

Select the output operation mode with **▲**, **▼** key.

(Pressing **M**Key momentarily, the output operation mode will be saved, then move to the next mode.)

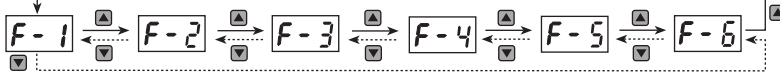

SPd and the previous response time will flicker by turning on.(0.5sec.)

Select the response time with **▲**, **▼** key.

(Pressing **M**Key momentarily, the response time will be saved, then move to the next mode.)



A-1 and the previous pressure will flicker by turning on.(0.5sec.)

Set the pressure which will output 1VDC with **▲**, **▼** key.

Allowable Setting range : Min. value of rating pressure ≤ **A-1** ≤90% of rating pressure

A-5 and the previous pressure will flicker by turning on.(0.5sec.)

Set the pressure which will output 5VDC by **▲**, **▼** key.

Allowable Setting range : **A-1** +10% of rating pressure ≤ **A-5** ≤Max. value of rating pressure

Loc and the previous key lock will flicker by turning on(0.5sec.)

Select key lock with **▲**, **▼** key.

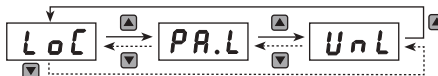

※Key protections

Loc : Unable to change preset value and Parameter value(Enable Key protection)

P.A.L : Able to change Preset value, Unable to change Parameter value

UnL : Able to change Preset value and Parameter value(Key protection off)

※When entering into Parameter setting mode and preset setting mode, it displays "Setting item" and "Previous setting value" by 0.5sec. turn.

This display will stop by pressing **▼** or **▲**Key(Display setting value), if no key touched for over 1 sec., it will display old value by 0.5sec. turn again.

※If no key touched for 60sec. during setting, it will display previous setting value not current setting.

※Please check preset value again when changing the output mode.

※If changing pressure display unit, preset setting value will be changed automatically.

※There is memory retention by EEPROM, but life cycle of EEPROM is 100,000 times.

Series SPSA

Preset value setting

Hysteresis mode(F-1) and 1 independent(F-3,F-4,F-5) output mode

Press **M** Key in Run mode.

M press one time → **M** press one time → **M** press one time → **M** press one time → RUN mode

Display alternates by 0.5sec.

Set the pressure detection level 1 by **▲**, **▼** key.
 Allowable setting range:
 Min. Value of setting pressure < St1 ≤ Max. value of setting pressure

Select the pressure detection level 2 by **▲**, **▼** key.
 Allowable setting range:
 · Hysteresis mode: Min. value of setting pressure ≤ St2 < St1
 · 1 independent output mode: Min. value of setting pressure < St2 ≤ Max. value of setting pressure.

Automatic sensitivity setting mode(F-2)

Press **M** Key in Run mode.

M press one time → **M** press one time → **M** press one time → **M** press one time → **M** press one time → RUN mode

Display alternates by 0.5sec.

After applying St1 in to Pressure port, then press **▲** Key.
 (Able to Set repeatedly by **▲** key)

After applying St2 in to Pressure port, then press **▲** Key.
 Allowable Setting Range :
 St1+1% of Setting Pressure ≤ St2 ≤ Max.Value of Setting Pressure

SET value will be calculated automatically and fine adjustment is available between St1 and St2 by **▲**, **▼** key.
 $SET = \frac{St1+St2}{2}$
 Adjustable Range of Set Value : between St1 and St2

Window (F-6)

Press **M** Key in Run mode.

M press one time → **M** press one time → **M** press one time → **M** press one time → RUN mode

Display alternates by 0.5sec.

Set Low setting value by **▲**, **▼** key.
 Allowable setting range:
 Min. setting pressure ≤ Lo < Max. value of setting pressure

Set High setting value by **▲**, **▼** key.
 Allowable setting range:
 Lo < Hi ≤ Max. value of setting pressure

- Please check the preset value again when changing output operation mode.
- When changing the display unit, preset value will be calculated according to the display unit.
- If no key is touched for 60sec., it will return to RUN mode. [automatic sensitivity setting mode(F-2) is exception]
- Whenever a key is touched one time, 2digits increased(decreased) but it will be continuously increasing(decreasing) by pressing key constantly.

Peak hold and Bottom hold

1. Press **▲** for more than 3sec, in RUN mode.
 2. **PEH** and memorized max. pressure(Negative type is for max. vacuum pressure) will flicker by turning on(0.5sec.)
 3. **boH** and memorized min. pressure(Negative type is for min. vacuum pressure) will flicker by turning on(0.5sec.) then display Bottom hold value.
 4. If press **▲** Key one time shortly, memorized Peak hold and Bottom hold value will be removed then return to RUN mode.
- * When the Peak hold and Bottom hold value is over the max. display pressure value, it displays **HHH**. On the opposite, it displays **LLL**.

Series SPSA

Output operation mode

SPSA

SPSB

Auto Switch

SPS

1. Hysteresis mode(F-1)

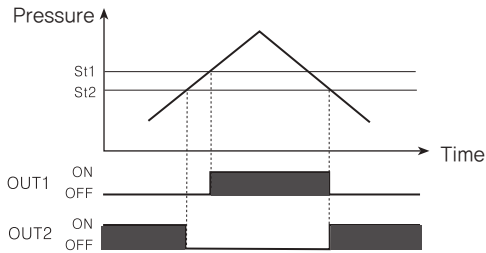

※It can be set for pressure detection level(St1) and detection difference(St2)

※St1 setting range : Min.value of specified prssure ≤ St1 ≤ Max.value of specified pressure

St2 setting range : Min.value of specified pressure ≤ St2 < St1

- OUT 1 : When applying pressure larger than St1, it will be ON.
- OUT 2 : When applying pressure lower than St2, it will be ON.

2. Automatic sensitivity setting mode(F-2)

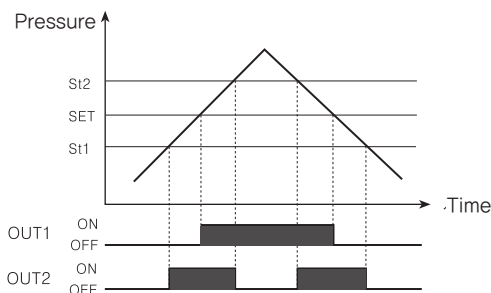

※This function is to set pressure detection level to the proper position automatically, it is set by received pressure from two position(St1, St2)

※SET value will be calculated as below.

$$\text{SET value} = \frac{\text{St1} + \text{St2}}{2}$$

- OUT 1 : When applying pressure larger than SET value, it will be ON.
- OUT 2 : When applying pressure between St1 and St2, it will be ON.

Note1) If there is not enough difference between St1

and St2, **Er3** will be displayed.

Please set again after applying enough pressure.

Note2) For fine adjustment for detection level, adjust detection level(SET) by Key.

(Adjustment range : Between St1 and St2)

3. Independent 2 output mode(F-3, F-4, F-5)

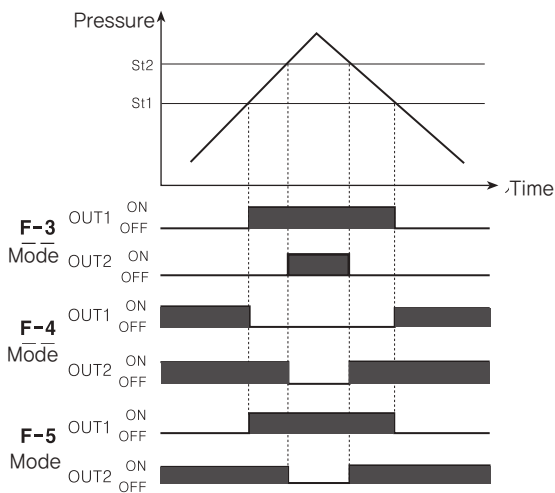

※St1 and St2 can be set independently within specified pressure range.

※One is for control, the other is for alarm or optional control.

※St1 setting range : Min.value of specified pressure ≤ St1 ≤ Max. value of specified pressure

St2 setting range : Min.value of specified pressure ≤ St2 ≤ Max. value of specified pressure

●2 Independent output mode(F-3)

- OUT 1 : It will be ON, when it is beyond St1.
- OUT 2 : It will be ON, when it is beyond St2.

●2 Independent opposite mode(F-4)

- OUT 1 : It will be OFF, when it is beyond St1.
- OUT 2 : It will be OFF, when it is beyond St2.

●2 Independent cross mode(F-5)

- OUT 1 : It will be OFF, when it is under St1.
- OUT 2 : It will be ON, when it is under St2.

4. Window mode(F-6)

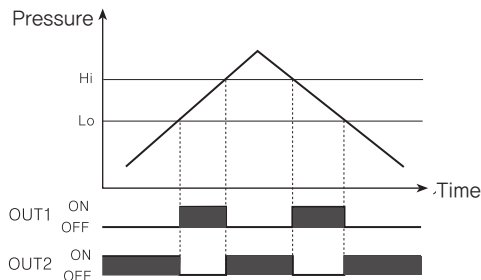

※Set Lo/Hi-limit value of pressure detection level in this mode.

※Lo setting range : Min.value of specified prssure ≤ Lo ≤ Max.value of specified pressure

Hi setting range : Lo < Hi ≤ Max.value of specified pressure

- OUT 1 : It will be ON between High limit value(Hi) and Low limit value (Lo)
- OUT 2 : It will be ON when it is beyond High limit value(Hi) and Low limit value (Lo)

Series SPSA

Function

1. Change of display unit

SPSA-V01(P) and SPSA-C01(P) has 7 kinds of pressure units. SPSA-01(P) and SPSA-1(P) has 4 kinds of pressure units. Please select the proper unit for application.

- SPSA-V01(P), SPSA-C01(P) : kPa, kgf/cm², bar, psi, mmHg, inHg, mmH₂O
- SPSA-01(P), SPSA-1(P) : kPa, kgf/cm², bar, psi

2. Change of output mode

There are 6 kinds of control output mode in order to realize the various pressure detection. Select a mode for your proper application.

- Hysteresis mode(F-1) : Change hysteresis for detecting pressure.
- Automatic sensitivity setting mode(F-2) : Set detection sensitivity automatically at proper position.
- Independent 2 output mode(F-3, F-4, F-5) : Detect pressure from two positions with one product.
- Window comparative output mode(F-6) : Detect pressure in certain areas.

3. Change of response time(Chattering prevention)

It can prevent chattering of the control output by changing response time. It is able to set 4 kinds of response times(2.5ms, 5ms, 100ms, 500ms) and if the response time is getting longer, the detection will be more stable by increasing the number of the digital filter.

4. Change of Analog output scale

Change properly for user a application. It setting A1 position for 1VDC output and A5 position for 5VDC output, the pressure range of A1 to A5 is to 5VDC analog output. Therefore analog output will be 1-5VDC between A1 and A5.

5. Key lock function

This unit has 2 kinds of key lock functions in order to prevent wrong operation.

- **Loc** : All keys are locked. It is impossible to change any parameter setting preset, Zero point adjustment, Peak hold and Bottom hold.(Able to change the status of lock)
- **PA.L** : This is partial locked status, it is impossible to change parameter setting(Able to change the status of lock) only, the rest of the functions can be changed.
- **UnL** : All of the setting are available, all keys are unlocked.

6. Zero point adjustment function

Set the display value pressure as Zero point forcibly.

7. Peak hold and Bottom hold function

Diagnosis malfunction of the system caused by parasitic pressure or check through memorizing the max. /min, pressure occurring from the system.

8. Error

Error display	Problem	Remedy
Er1	If external pressure applied, when adjusting Zero point	Please try again after external pressure removing
Er2	When overloaded on control output	Remove overload
Er3	When the setting value is not matched with setting condition	Set proper setting value after checking setting condition
HHH	When the applied pressure exceeds the upper display pressure range up	Apply pressure within display pressure range
LLL	When the applied pressure exceeds the lower display pressure range down	

Installation

1. When installing the pressure port it is able to bring pressure from 3 directions by changing the mounting direction of the pressure port.
2. Pressure port is PT1/8 and it is able to use general one touch fittings.
3. Please use seal tape at port plug in order to prevent pressure leak.
4. Please block another two pressure ports not used with port plugs.
5. Please connect it by using spanner(13mm) at the metal part in order not to overload the body when connecting one touch fittings.

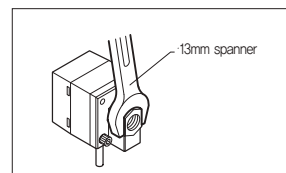
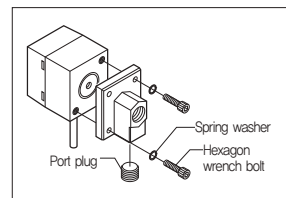
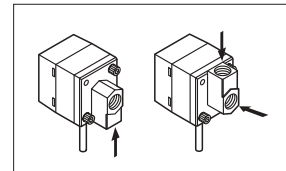

⚠ Caution

The tightening torque of one touch fitting should be Max 10N·m.

6. SPSA series has 2 kinds of brackets so it is able to install two different ways.
7. At first, please unscrew hexagon wrench bolt and assemble the bracket on this unit by fixing the hexagon wrench bolt. In this case, tightening torque of hexagon wrench should be max. 3N·m.

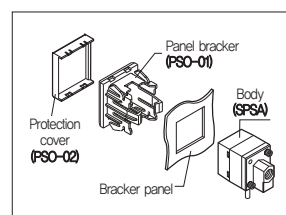
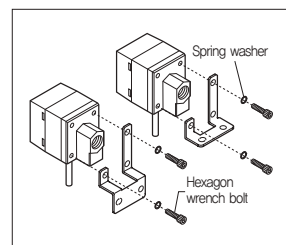

8. Bracket(PSO-01) and front protection cover(PSO-02) are optional to sell. Please see the pictures for installation.

Series SPSA

Accessories

SPSA

SPSB

Auto Switch

SPS

• Pressure unit label

±100kPa -101.3kPa 100kPa 1MPa			
±1.020kgf/cm ²	-1.034kgf/cm ²	1.020kgf/cm ²	10.20kgf/cm ²
±14.50psi	-14.70psi	14.50psi	145.0psi
±1.000bar	-1.013bar	1.000bar	10.00bar
±750mmHg	-760mmHg	X10	X10
±29.5inHg	-29.9inHg	X100	X100
±102.0mmH ₂ O	-103.4mmH ₂ O	X1000	X1000

DISPLAY UNIT LABEL

• Port Plug

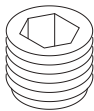

• Bracket A

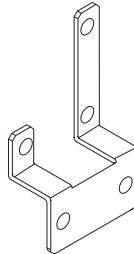

• Bracket B

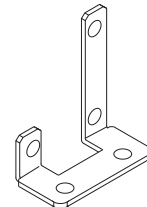

Caution for using

1. Do not insert any sharp or pointed object into pressure port. It may cause mechanical trouble due to sensor damage.
2. This unit must avoid direct contact with water, oil, thinner etc.
3. Be sure to avoid transient time(within 3sec.) after initial power on.
4. When a switching moving regulator is used for the power supply, the frame ground(F.G) terminal of the power supply must be grounded.
5. When moving this unit from a warm place to a cold place, please remove the humidity on the cover.
6. Do not press the setting button with sharp or pointed object.
7. Do not put over 30N tensile strength on connection part or load.
8. When using mmH₂O unit, please multiply display value by 100.

※ Malfunctions may occur if the above instructions are not followed.

